

SPECIFICATIONS

DESCRIPTION

- Flexible connectors for easier installation
- Supplied with 15mm double check valves

FLOW

- Recommended working pressure 0.5 bar/7.5PSI
- Maximum 5 bar/ 75 PSI
- 8L /min at 1 bar
- 14L /min at 3 bar

WARRANTY

- www.perrinandrowe.co.uk

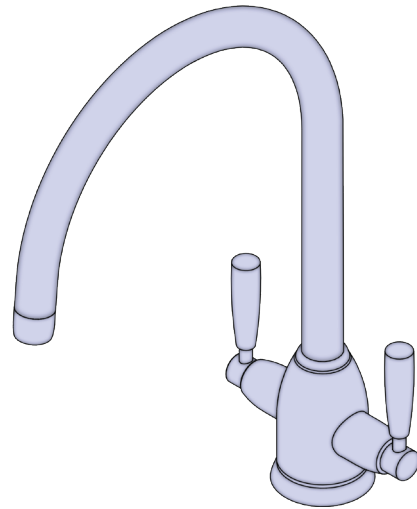

Monobloc Sink Mixer

MODELS: 4861

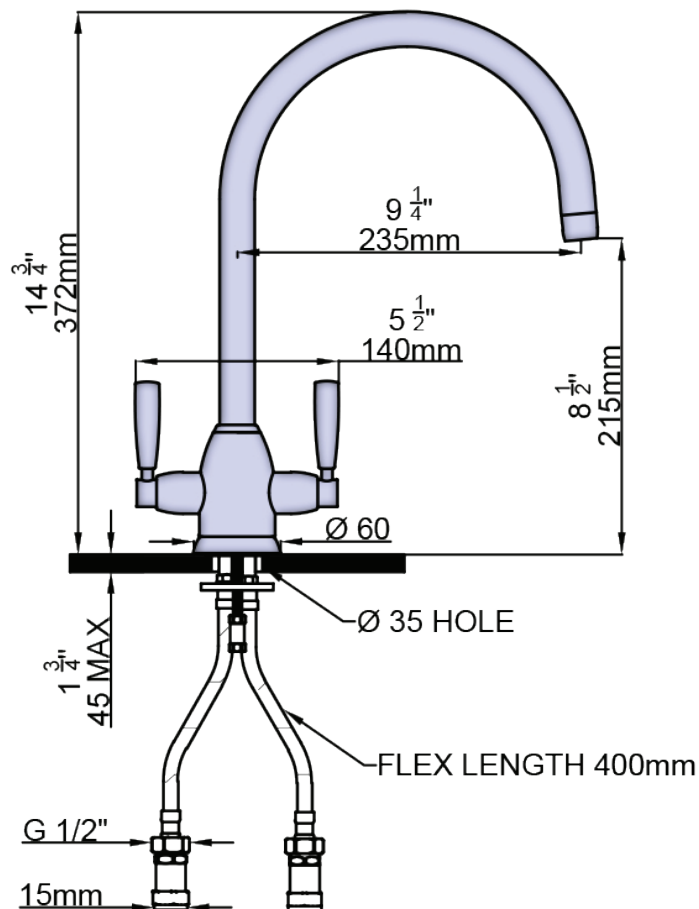

+44 (0) 1708 526 361

www.perrinandrowe.co.uk

A DISTINCTIVE MEMBER OF THE HOUSE OF ROHL