

SPECIFICATIONS

DESCRIPTION

- Fully extended reach 600mm
- Mounting wall plugs/screws and plate supplied
- Concealed wall fixings

FLOW

- Recommended working pressure 0.5 bar/7.5PSI
- Maximum 5 bar/ 75 PSI
- 4L /min at 1 bar
- 8L /min at 3 bar

WARRANTY

- www.perrinandrowe.co.uk

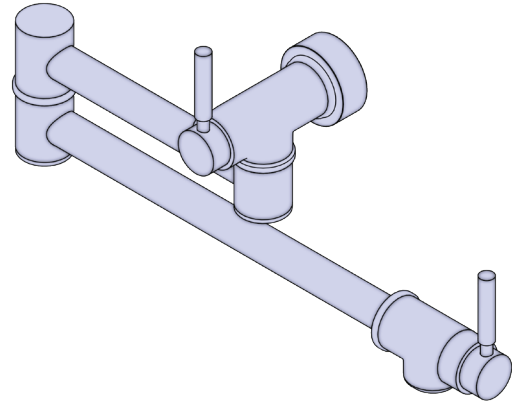

Pot Filler

MODELS: 4899

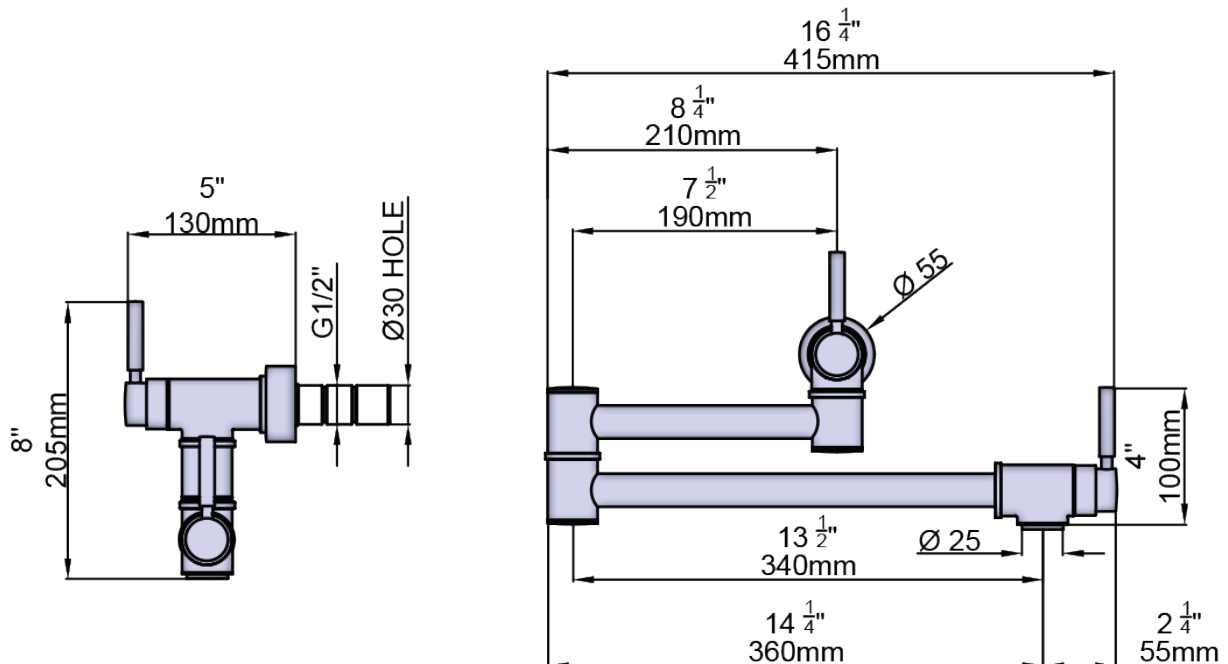

+44 (0) 1708 526 361

www.perrinandrowe.co.uk

A DISTINCTIVE MEMBER OF THE HOUSE OF ROHL